

## Coffee System

# TANGO ACE, 1 group full-automatic machine with Cappuccinatore

ITEM # \_\_\_\_\_

MODEL # \_\_\_\_\_

NAME # \_\_\_\_\_

SIS # \_\_\_\_\_

AIA # \_\_\_\_\_

**602556 (TANGOACEILC)**

Full-automatic machine, 1 group, 220x40 ml espresso cup/hr, 6,5 liter steam/coffee boiler, 1x1,7 kg and 1x1,2 kg coffee hopper, programmable water and steam, Tango Cappuccinatore device with double function L: for hot milk and C: for foam by air injection

### Short Form Specification

#### Item No.

The super automatic coffee machine Tango® Ace impresses its users with an exceptional result in every cup, and the quality of its equipment makes it a highly reliable choice for demanding professional use.

The Tango® Ace comes in 3 different colors: shiny white, glossy black and brushed stainless steel, fitted with a new 7" color touch screen user interface. This full automatic coffee machine has a 48 drinks menu, all customizable and comprehensive with the addition of the Cappuccinatore device to process fresh into specialty coffee drinks as cappuccino, latte, mocha...

Delivery capacity:

Espresso 40ml : 220 cups/h

Lungo 100ml : 150 cups/h

Hot water : 30 L/h

Cappuccino 100ml: 170 cups/h

Latte 100ml: 150 cups/h

### Main Features

- 1 group full-automatic machine.
- 6.5 liter steam/coffee boiler.
- Auto cleaning program.
- Programmable water and steam.
- Tango Cappuccinatore device with double feature L: for hot milk and C: for foam by air injection.
- The super automatic coffee machine Tango® Ace impresses its users with an exceptional result in every cup, and the quality of its equipment makes it a highly reliable choice for demanding professional use.
- The Tango® Ace comes in 3 different colors: shiny white, glossy black and brushed stainless steel, fitted with a new 7" color touch screen user interface. This full automatic coffee machine has a 48 drinks menu, all customizable and comprehensive with the addition of the Cappuccinatore device to process fresh into specialty coffee drinks as cappuccino, latte, mocha...
- Delivery Capacity:
  - Espresso 40ml: 220 cups/h
  - Lungo 100ml: 300 cups/h
  - Hot Water: 56 L/h
  - Cappuccino 100ml: 240 cups/h
  - Latte 100ml: 180 cups/h

### Construction

- 2 coffee grinders (1 x 1,7 kg & 1 x 1,2 kg coffee hoppers).
- LCD Touchscreen.
- PID (proportional-integral-derivative) Temperature control: a precise controller algorithm system that gives consistency and accuracy to brewing temperature management system.

### Optional Accessories

- Side milk refrigerator 8 liter nominal capacity for up to 4 liter milk containers PNC 871014
- Side milk refrigerator 8 liter nominal capacity for up to 4 liter milk containers with digital display PNC 871015
- TANGO hotel/breakfast service kit PNC 871022
- Coffee ground direct discharge chute PNC 871023
- Raised feet kit PNC 871041

APPROVAL: \_\_\_\_\_

Front

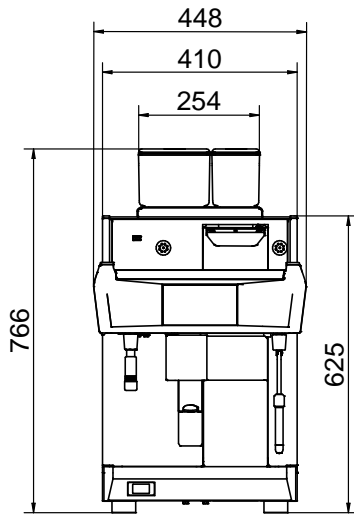

Side

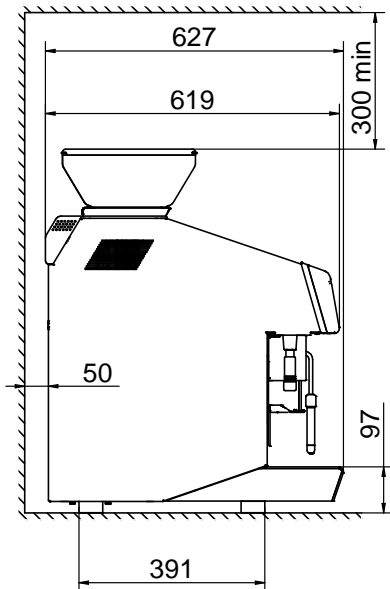

Top

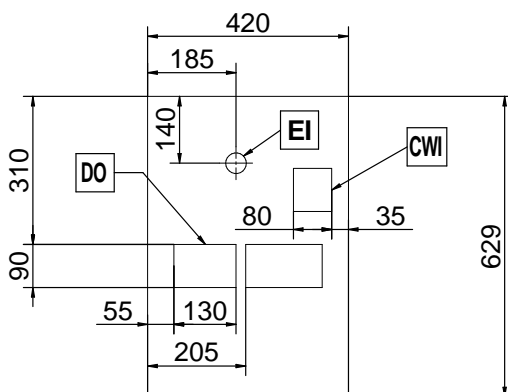

### Electric

#### Supply voltage:

602556 (TANGOACE1LC) 400 V/3N ph/50 Hz

#### Electrical power max.:

5.2 kW

#### Plug type:

Cable without plug

### Water:

#### Cold water temperature

(min/max): 5 / 60 °C

### Key Information:

External dimensions, Width: 448 mm

External dimensions, Depth: 627 mm

External dimensions, Height: 846 mm

Net weight: 103 kg

 Shipping volume: 0.69 m<sup>3</sup>

### Sustainability

Current consumption:

7.5 Amps